

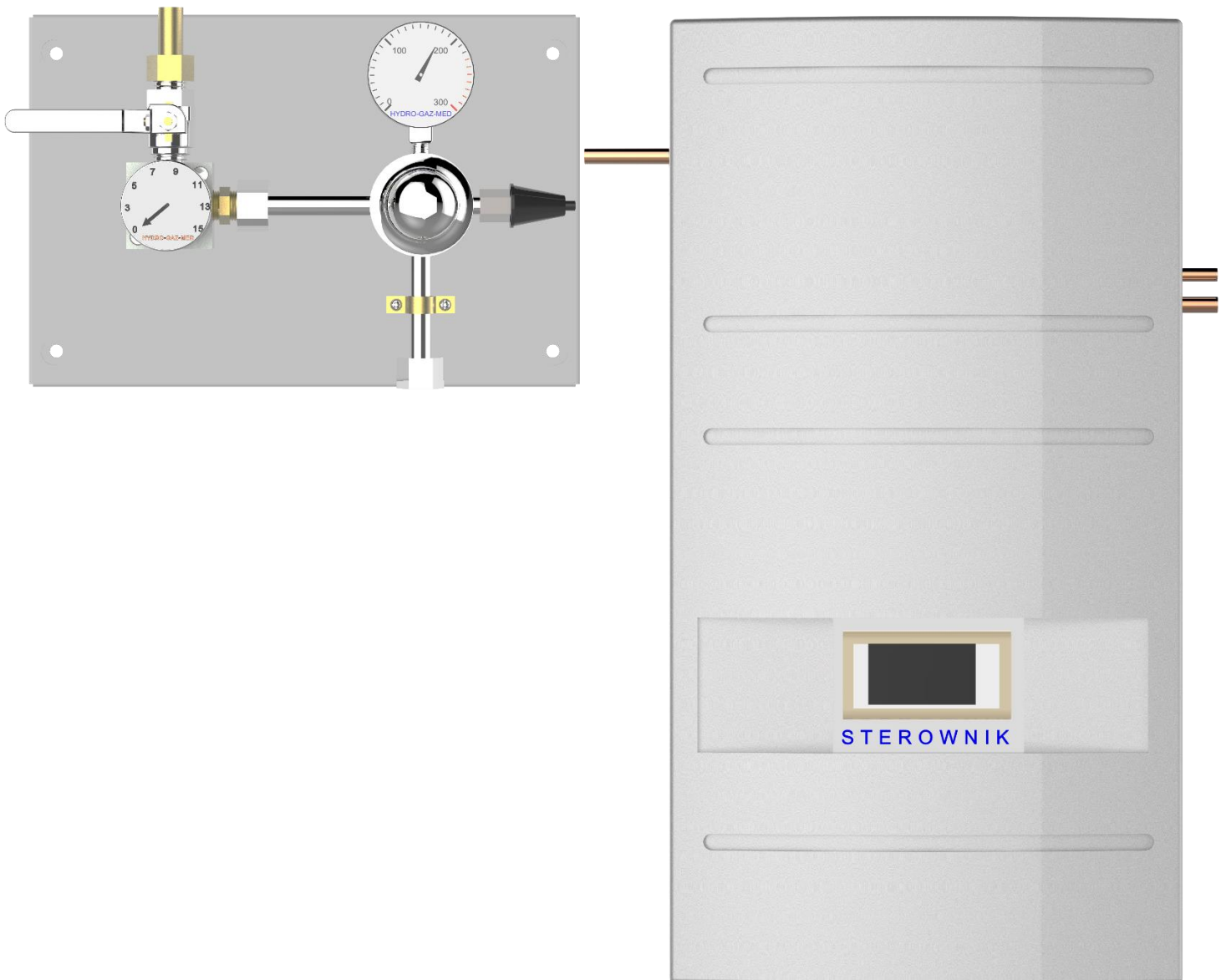

**HYDRO-GAZ-MED**  
MEDICAL EQUIPMENT MANUFACTURER  
Willowa 40 St., 05-205 Dobczyn, Poland  
☎ +48 22 787 65 60 / +48 606 348 532 📠 +48 22 487 98 53  
💻 www.gazmed.pl / ✉ gazmed@gazmed.pl

# SWITCH CABINET „PNEUMAT”

Complies with EN ISO 7396-1:2016-07



USER MANUAL



## TABLE OF CONTENTS:

|  |    |
|--|----|
| 1. Application .....                                 | 3  |
| 2. Technical specification .....                     | 3  |
| 3. Description of operation .....                    | 4  |
| 4. Installation .....                                | 5  |
| 5. Alarm system .....                                | 5  |
| 5.1 Information on the panel .....                   | 5  |
| 5.2 Wiring description.....                          | 6  |
| 5.3 Alarm unit .....                                 | 6  |
| 5.3.1 Alarm unit – on plaster version .....          | 6  |
| 5.3.2 Alarm unit description.....                    | 7  |
| 5.3.3 Installation.....                              | 7  |
| 5.3.3.1 Installation procedure.....                  | 8  |
| 5.4 Alarm unit - flush-mounted version.....          | 8  |
| 5.4.1 Installation of flush-mounted alarm unit ..... | 9  |
| 5.5 Connecting cables .....                          | 10 |
| 6. First start-up .....                              | 11 |
| 7. Control system.....                               | 12 |
| 7.1 Display of the controller.....                   | 12 |
| 7.2 Operation of the controller .....                | 12 |
| 8. Maintenance/emergency supply point. ....          | 12 |
| 9. Maintenance / Inspection .....                    | 12 |
| 9.1 Inspection .....                                 | 13 |
| 9.2 Maintenance .....                                | 13 |
| 9.3 Spare parts list.....                            | 13 |
| 9.4 List of service points .....                     | 13 |
| 10. Diagram of "PNEUMAT" supply system .....         | 14 |
| 11. Construction diagram .....                       | 15 |
| 12. Single stage reserve panel.....                  | 16 |
| 13. Double stage reserve panel .....                 | 16 |

## 1. Application

The device is designed to supply the compressed medical gases to central pipeline system and is a medical device of class IIb.

Central supply panel PNEUMAT II reduction plate guarantees constant supply of compressed medical gases as per PN-EN ISO 7396-1 standard.

### **The system consists of two components:**

- Central supply panel PNEUMAT II reduction plate
- PNEUMAT back-up panel

### **The system is adapted for:**

- 2 cylinder batteries + back-up supply from the cylinder
- Tank with liquefied gas + 2 cylinder batteries
- Air compressor + 2 cylinder batteries

Electronic switching system controls and monitors the supply of the gas to the distribution system, while reducing the pressure of cylinder batteries.

## 2. Technical specification

Construction: double, two-stage pressure reduction with automatic switching system, pressure relief valves for I degree medium pressure and secondary working pressure, NIST emergency supply point.

The possibility of adding the third reserve bank.

|   |                             |
|---|-----------------------------|
| Dimensions: PNEUMAT IV Reduction Plate        | 850x400x200 (WxHxD),        |
| Weight:                                       | ca. 15 kg                   |
| Dimensions of PNEUMAT back-up panel:          | 350x280x150                 |
| Weight of back-up panel:                      | 2 kg                        |
| Capacity:                                     | 30-50 Nm <sup>3</sup> /h    |
| Inlet:  | G1/2"                       |
| Inlet pressure:                               | max. 200 bar                |
| Outlet pressure:                              | 4.5 – 5.5 bar               |
| Outlet:                                       | copper pipe Ø 15 mm         |
| Relief valves:                                | copper pipe Ø 12 mm         |
| Electrical supply:                            | 12 V DC,                    |
| Cross-section of the power cord:              | 2 x 0.5 mm <sup>2</sup>     |
| Cable to remote signalling device (optional): | 4-pair UTP or FTP wire coil |

## **Working pressure of the reducers**

|  |                |
|--|----------------|
| Right high pressure reducing valve:            | 9 bars         |
| Left high pressure reducing valve:             | 10 bars        |
| High pressure reducing valve on back-up panel: | 7.0 bars       |
| Network reducers:                              | 4.5 to 5.5 bar |

## **Media**

- Oxygen
- Nitrous oxide
- Carbon dioxide
- Compressed air
- Nitrogen
- Argon

## **3. Description of operation**

PNEUMAT central supply panel reduction plate has been designed to ensure the continuity of supply of gas delivered in steel or aluminium cylinders under high pressure.

Gas is supplied from the cylinder through the high pressure collector to the change-over system. High pressure in the cylinder is reduced in two stages. Two high pressure reducers reduce the high pressure from the cylinder to a medium pressure. The reducer from the left side is set to a pressure of 10 bars, and the right one to 9 bar. Primary pressure section is equipped with a relief valve which opens at a pressure of 11 bars.

The average pressure is reduced by two low pressure reducers to the pressure on the network. Each reducer has a capacity that corresponds to the rated output of the system, e.g. if one of the reducers is removed or being serviced, the system continues to work with the nominal capacity. When the pressure in the network exceeds 7 bars, the relief valve opens.

Maintenance Connection Point (NIST) allows supplying the network from a cylinder fitted with a pressure regulator and a hose with a NIST-connector in the event of a failure or maintenance.

During the emergency supply the relevant shut-off valves are closed, and when the failure is removed or maintenance work is completed the system must be restarted as per "Fisrt start-up" section.

During normal operation, a switching system is supplied by one battery, while the other is available as a back-up supply. Automatic switching system is based on two solenoid valves

that are normally open and during normal operation one solenoid valve remains live and closed.

**NOTE!**

If coils of solenoid valve are closed, they become heated!

The coil that remains live brings up to a temperature of ca. 70°C. Change of sequence of operation takes place through the electronic controller.

**NOTE:**

The system is working properly at the correct pressure on high and low pressure reducers.

No collection of gas can result in a slight increase in pressure at 1 degree of reduction.

#### **4. Installation**

The installation can be performed only by trained personnel.

Only copper tubes for medical gases as per PN-EN 13348 standard can be used for installation.

Tests and acceptance protocols for the system must be kept.

All pipes and connections must be free of oil and grease!

**Checklist:**

1. Securing the plate to the wall
2. Securing of cylinder batteries to the wall
3. Connection of the cylinder batteries to reduction plate
4. Pulling out of ventilation tubes from the relief valves (does not apply to compressed air) and cylinder batteries outside, air pipes de-pressurizing cylinder batteries and relieving pressure from the panel must be run separately
5. After completion of installation, blow the whole system.

#### **5. Alarm system**

##### **5.1 Information on the panel**

Supply should be connected to the junction box on the panel with a 2 x 0.75 mm<sup>2</sup> 12V DC cord.

**NOTE!**

**Improper polarity may result in damage to the electronics!**

2 x 0.5 mm<sup>2</sup> cable from the pressure sensor on the back-up panel should be supplied to the junction box and connected according to the diagram.

## 5.2 Wiring description

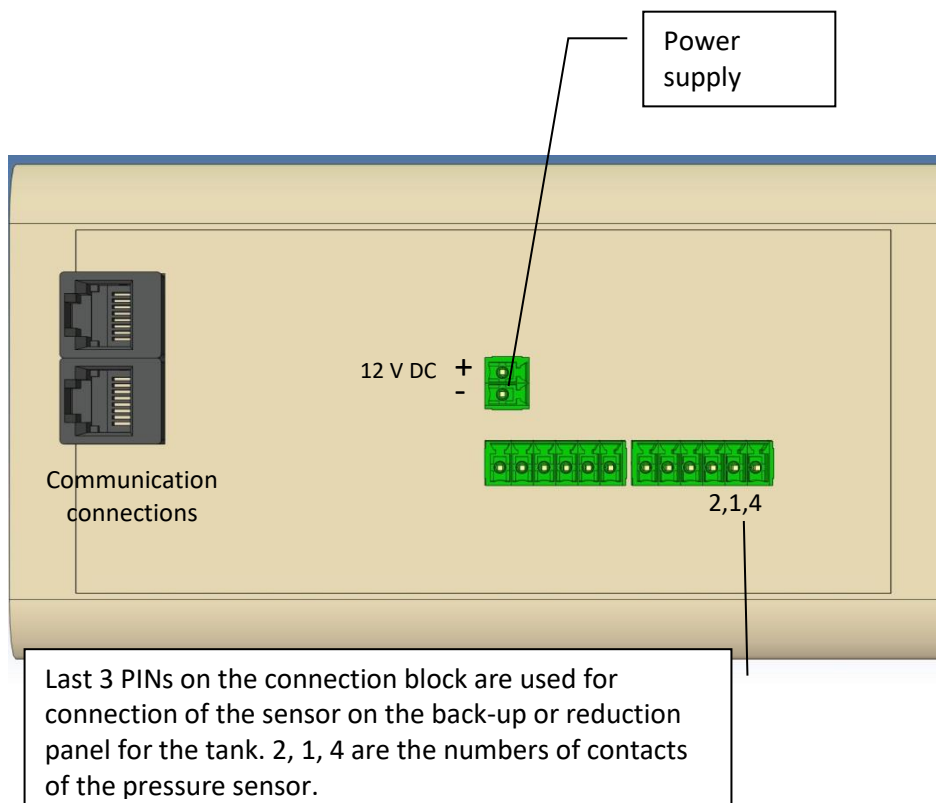

## 5.3 Alarm unit

### 5.3.1 Alarm unit – on plaster version

Remote signalling device is equipped with LCD touch screen on which TEST button is placed used for periodical check of the correct operation of the audio and visual signal.

On the cover, there is a two-colour LED from the visual signal. In the event of a low-pressure alarm of any of the gases, LED is blinking red, in the event of a high-pressure alarm, the diode is blinking green.

In case of any alarm, audio signal may also be heard.

To silence the audible alarm it is required to touch the bell icon, after a period of 15 minutes an audible signal returns. Alarm disappears intrinsically when the pressure is back to normal.

During normal operation green LED is permanently lit.

### 5.3.2 Alarm unit description

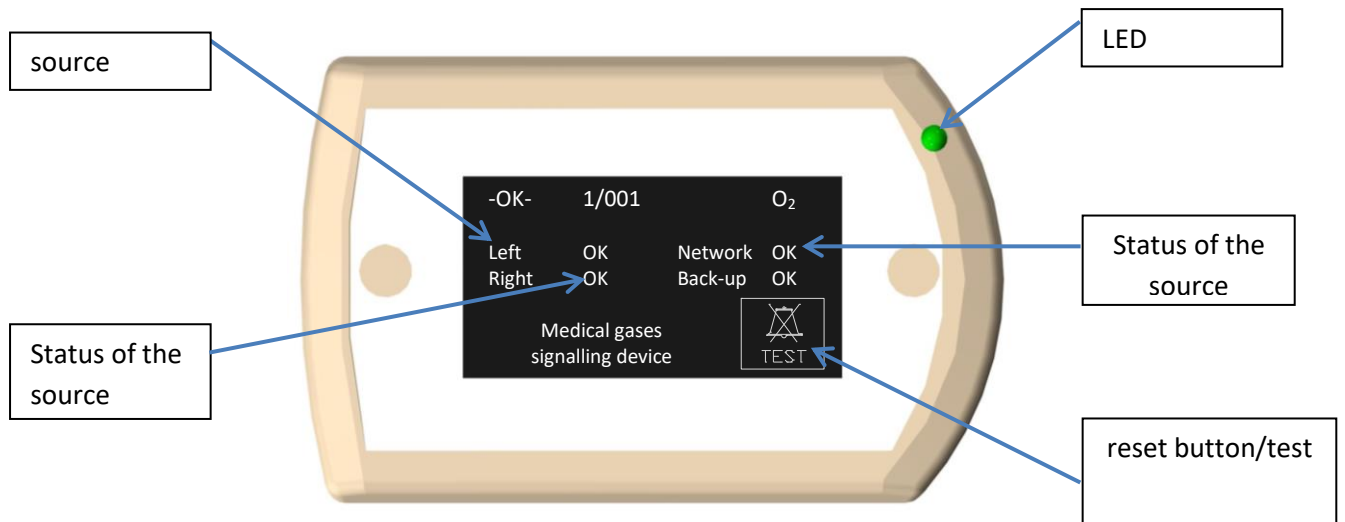

### 5.3.3 Installation

Along with the signalling device, the following is supplied:

- Flush-mounted junction box
- Screws + dowel
- Hole plugs for the mounting holes

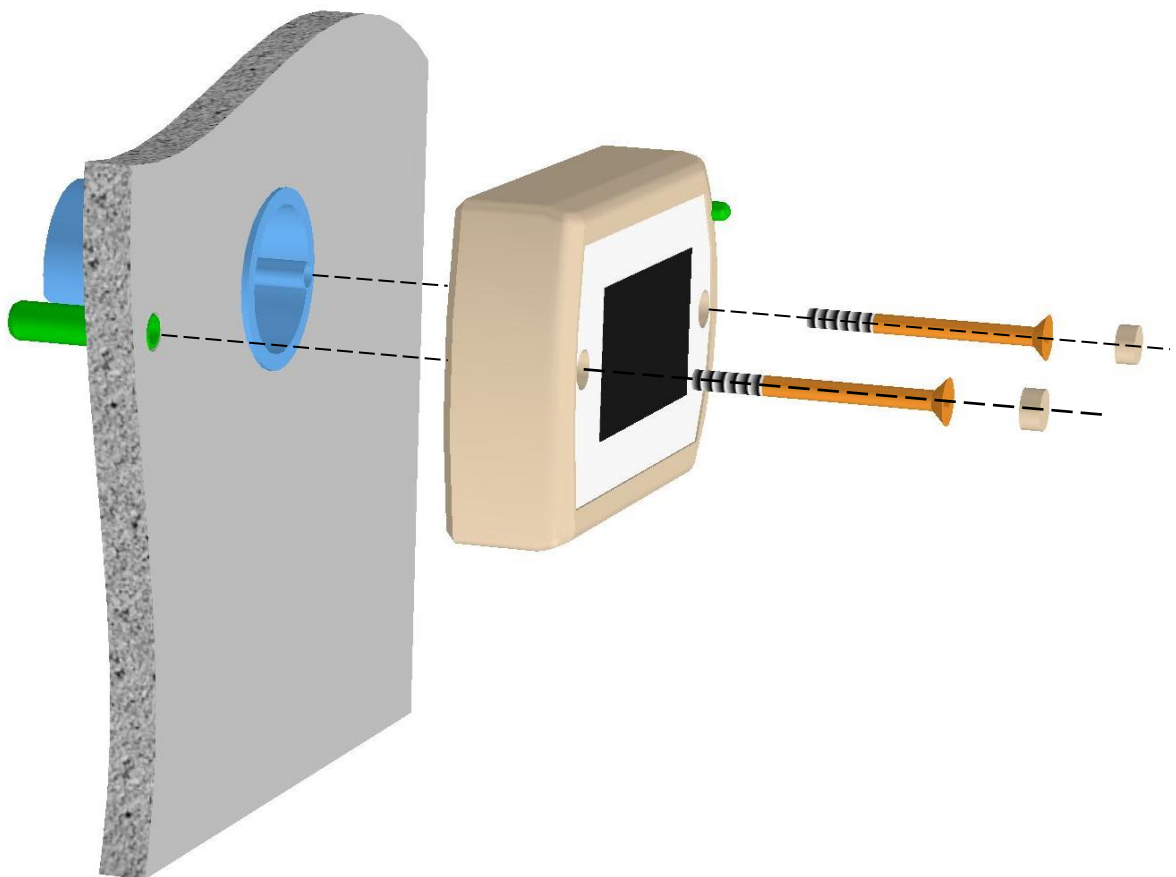

### 5.3.3.1 Installation procedure

1. Install a junction box
2. Screw the signalling device using the supplied screws into the hole in the junction box
3. Mark the position of the second hole
4. Drill a hole and insert the dowel
5. Prepare the signalling cable (*see point 9.3.2*)
6. The cable to protrude max. 5-8 cm from the wall
7. Put the plug into signalling device
8. Screw the signalling device with supplied screws
9. Insert the supplied hole plugs in the holes for the screws

### 5.4 Alarm unit - flush-mounted version

Features: displays information about the status of the monitored gases and visual and acoustic signalisation of the alarm conditions. Remote alarm unit operates in the same way as the alarm unit installed in the box.

Power consumption: < 250 mA

Length: 180 mm

Width: 90 mm

Height: 42 mm

Weight: ca. 200 g





5.4.1 Installation of flush-mounted alarm unit

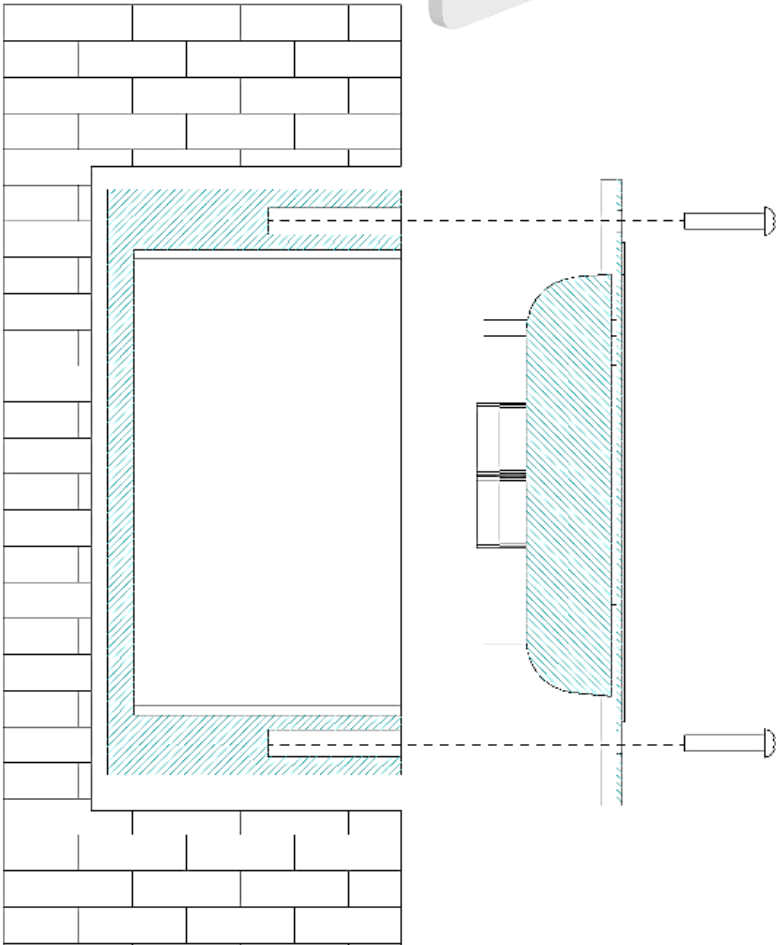
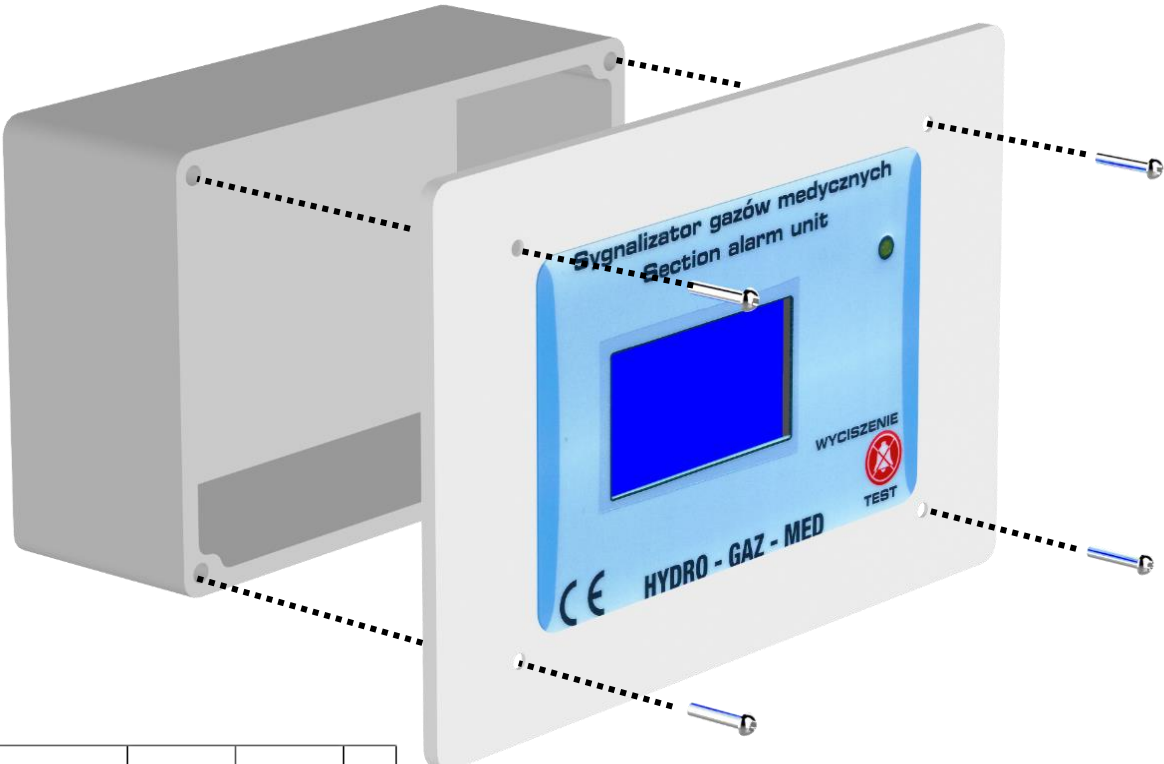

## 5.5 Connecting cables

In order to connect the remote signalling device (mounted in the operating room or ICU, etc.), use a standard UTP or FTP cable (twisted-4-pair wire Category 5 or higher). All transmission cables must be terminated with the typical RJ-45 connectors. Connecting cables do not have interlaces.

Controller box on PNEUMAT panel contains relay module with two RJ-45 slots for connecting transmission cables. To a free slot, connect one end of the signalling cable terminated with RJ-45 connector.

Free slot in the control panel is used to connect to BMS system of Hydro-Gaz-Med.

Diagram of the cable and recommended wire colours:

- |         |       |       |                |
|---------|-------|-------|----------------|
| • PIN 1 | ————— | PIN 1 | - green        |
| • PIN 2 | ————— | PIN 2 | - blue         |
| • PIN 3 | ————— | PIN 3 | - brown        |
| • PIN 4 | ————— | PIN 4 | - orange       |
| • PIN 5 | ————— | PIN 5 | - orange-white |
| • PIN 6 | ————— | PIN 6 | - brown-white  |
| • PIN 7 | ————— | PIN 7 | - blue-white   |
| • PIN 8 | ————— | PIN 8 | - green-white  |

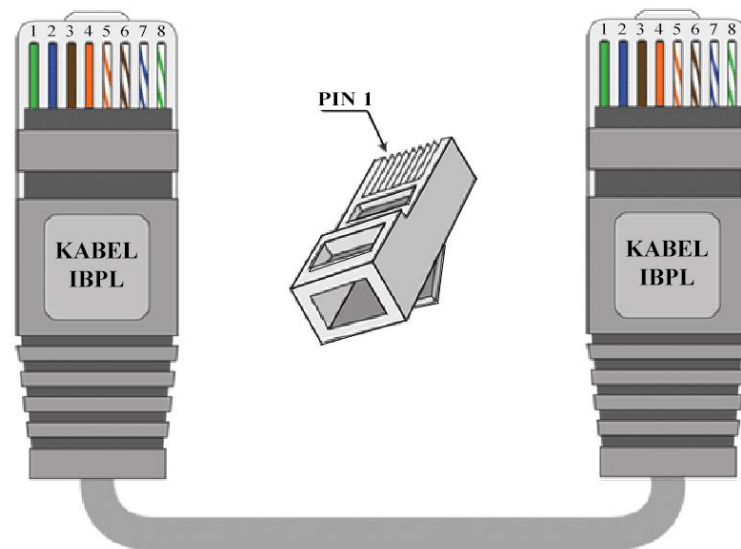

Too short transmission cables can be extended by combining them with a use of **adapters**, and in each empty slot of the **adapter** there must be a terminator.

The plug is placed in the rear panel of the signalling device.

Information messages on a remote signalling device:

- |                         |                  |  |
|-------------------------|------------------|--|
| • <b><u>Left</u></b>    | <b><u>OK</u></b> | <b><u>- correct status</u></b>                             |
| Left                    | 50%              | - left battery pressure below 75 bars                      |
| Left                    | MIN              | - left battery empty, pressure below 8 bars                |
| • <b><u>Right</u></b>   | <b><u>OK</u></b> | <b><u>- correct status</u></b>                             |
| Right                   | 50%              | - right battery empty (below 10 bar)                       |
| Right                   | MIN              | - right battery pressure below 75 bars                     |
| • <b><u>Network</u></b> | <b><u>OK</u></b> | <b><u>- correct status</u></b>                             |
| Network                 | MIN              | - too low pressures in the network ( <i>below 4 bars</i> ) |
| Network                 | MAX              | - too high pressures in the network ( <i>over 6 bars</i> ) |
| • <b><u>Back-up</u></b> | <b><u>OK</u></b> | <b><u>- correct status</u></b>                             |
| Left                    | 50%              | - back-up battery pressure below 75 bars                   |
| Back-up                 | MIN              | - back-up empty pressure below 8 bars                      |

## 6. First start-up

Prior to commissioning, the system must be vented, all shut-off valves must be closed.

**Installation must be finished completely!**

**It is required to make sure whether electric cables are correctly connected and the voltage is correct!**

**Slowly** open the main valves on the cylinder batteries.

1. Open slowly the valves on the left side of the cylinder
2. Observe the pressure on the I degree pressure gauge, it must be constant and equal to 10 bars.
3. Wait about one minute, if the pressure is correct;
4. Close the valve on the cylinder and de-pressurize the collector;
5. Open the valve on the right side of the cylinder
6. The pressure on the I degree pressure gauge should be about 1 bar lower and equal to 9 bar.
7. If after 1 minute the pressure does not change, perform steps 11-15.
8. If the pressure increases slowly, the reducer must be checked.
9. Open the low-pressure valves (the lines operate independently)
10. Observe the pressure on the II degree pressure gauge, it must adjust to the network pressure and remain constant. **NOTE: If the pressure increases slowly, check the reducer**
11. Switch on power supply.
12. Lower pressure side will start operation as first (*green arrow on the display from the left or right side of pictogram of reduction plate*)
13. Slowly open the valve to let the gas into the installation.

14. Observe the pressure on the II degree pressure gauge; it must adjust to the network pressure.
15. The pressure in the network is controlled by the setting knobs on the network reducers.

## 7. Control system

### 7.1 Display of the controller

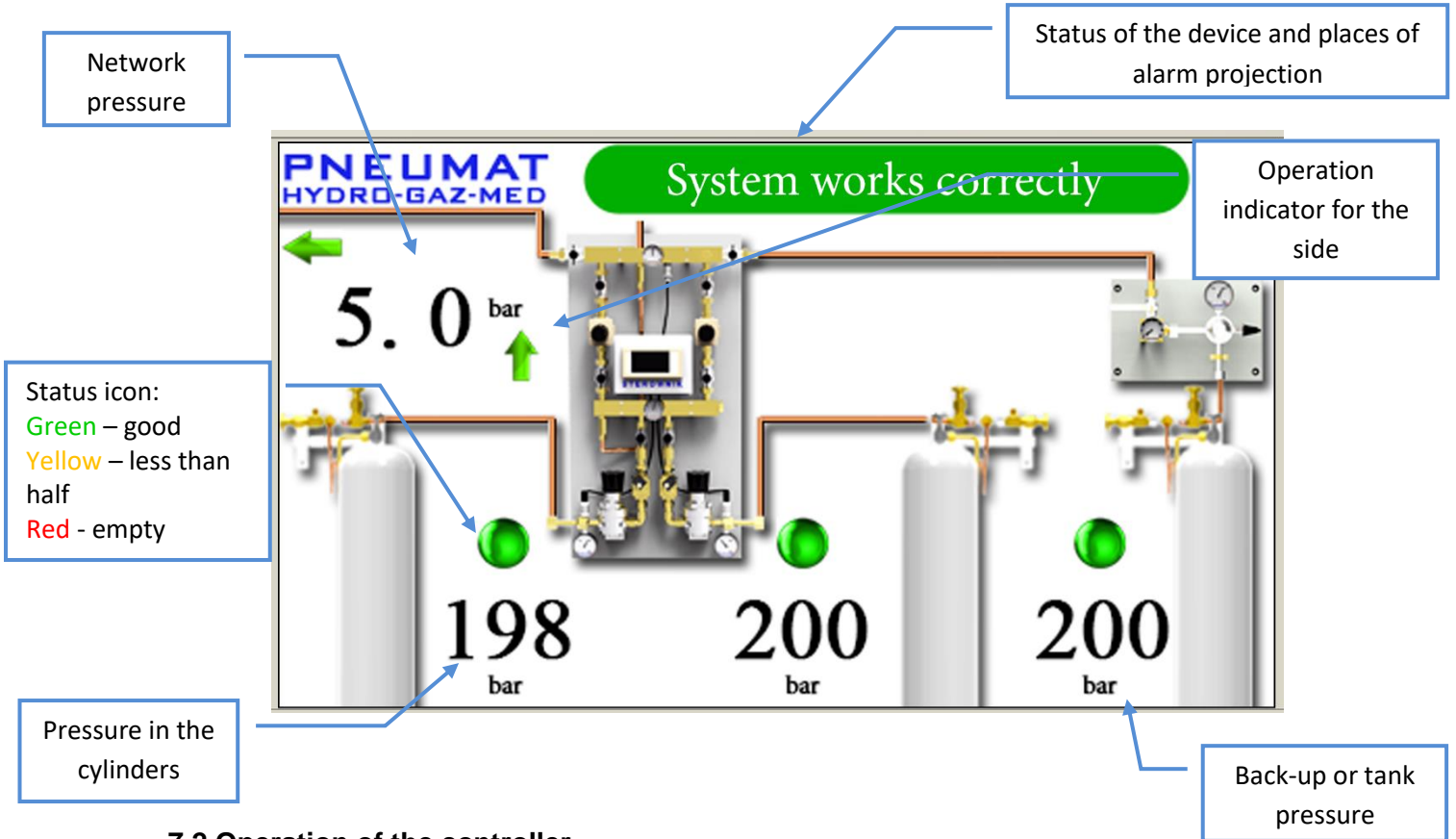

### 7.2 Operation of the controller

The controller monitors the proper operation of the reduction table and ensures the continuity of gas supply.

The controller also allows selecting manually the left or right side, just tap the field with the pressure to have the sides switched.

In case of a low pressure in the network, both sides will open at the same time in order to ensure the correct pressure in the pipeline network.

## 8. Maintenance/emergency supply point.

NIST connection has been used, in the event of use, the back-up cylinder with reducer set to working pressure, should be connected.

The valves of II degree reducers must be closed.

## 9. Maintenance / Inspection

## 9.1 Inspection

The whole gas distribution system should be subjected to a visual inspection at regular intervals; the inspection should be carried out by qualified personnel checking the functions and pressure conditions.

## 9.2 Maintenance

System maintenance is recommended every 12 months and may be carried out only by qualified technical personnel. It includes among others: checking pressure conditions, leak tightness of screwed connections, leak tightness of valves. All service parts should be replaced every 5 years.

If any parts need to be removed for repair or maintenance, appropriate shut-off valves before and after the part should be closed. Doubled construction of the reduction plate will ensure continuous supply of gas to the network, without the need for additional adjustment of the reducers.

If the system must be dismantled for a short time (repair, periodic replacement of the parts), it is possible to feed the system by the emergency supply point. During the emergency supply, the supply network valve remains open. To restart the system, please follow the installation instructions.

## 9.3 Spare parts list.

- |   |                     |
|---|---------------------|
| 1. Maintenance kit for high pressure reducer -  | cat. no.: ZNRB200   |
| 2. Maintenance kit for the network reducer -  | cat. no.: ZNRS10    |
| 3. The relief valve 11 bars -   | cat. no.: ZNAD11B   |
| 4. The relief valve 7 bars -  | cat. no.: ZNAD7B    |
| 5. NIST connection –  | cat. no.: NIST- (x) |
| (in place of (x), enter the symbol of gas: O2 - Oxygen, AIR-air, N2O - nitrous oxide, CO2 - carbon dioxide, N - nitrogen, AR - argon) |                     |
| 6. High pressure converter –  | cat. no.: GEMS250   |
| 7. Low pressure converter –   | cat. no.: GEMS16    |

## 9.4 List of service points

**HYDRO-GAZ-MED Sp.J.**  
Willowa 40 St.  
05-205 Dobczyn, Poland  
tel. +48 22 787 65 60  
fax +48 22 487 98 53  
gazmed@gazmed.pl

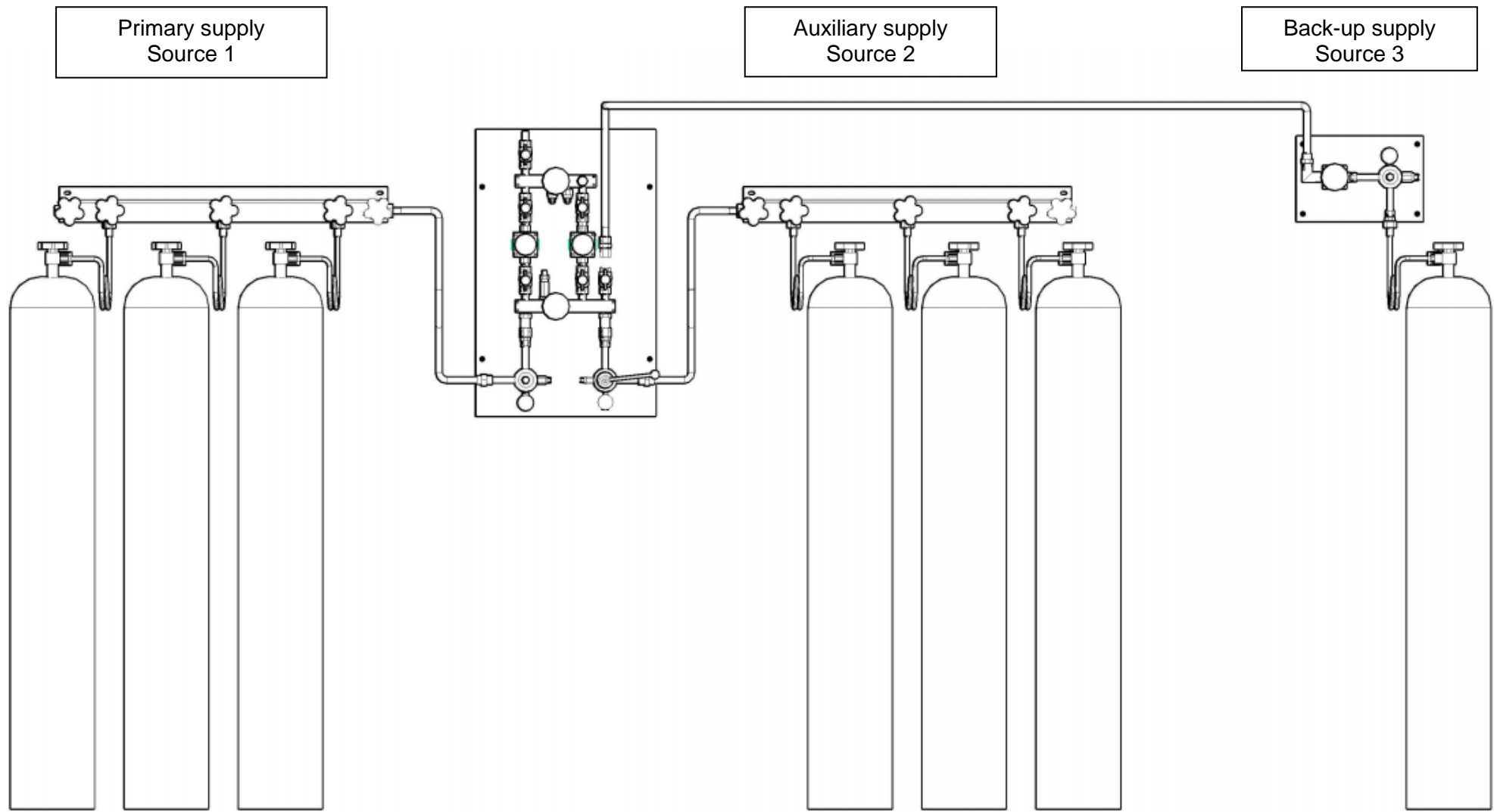

10. Diagram of "PNEUMAT" supply system

11. CONSTRUCTION DIAGRAM

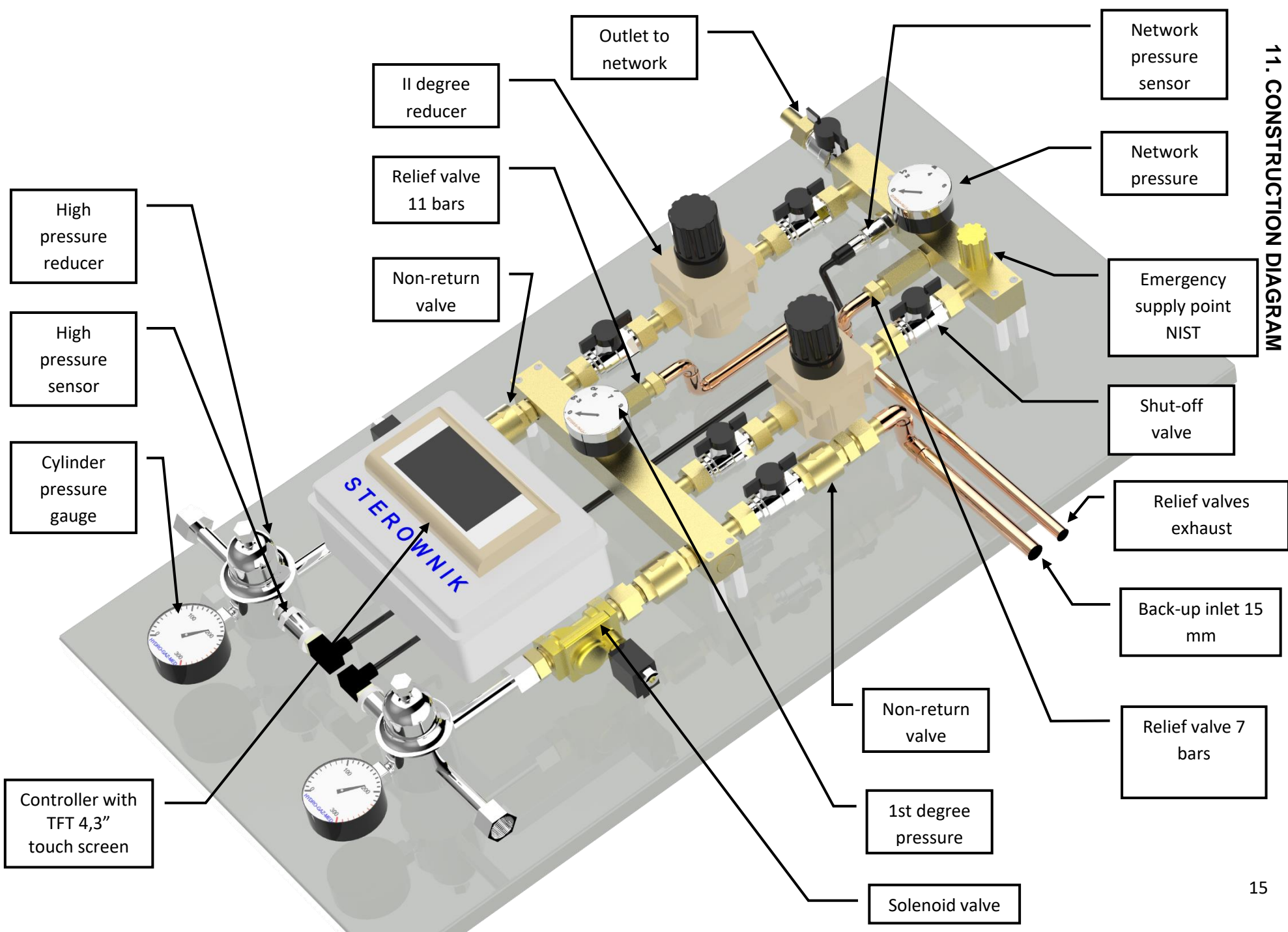

### 12. Single stage reserve panel

Meant to reduce pressure from high pressure cylinder reserve and supply pipeline network. It is meant to be connected to PNEUMAT switch cabinet which serves as second stage reduction.

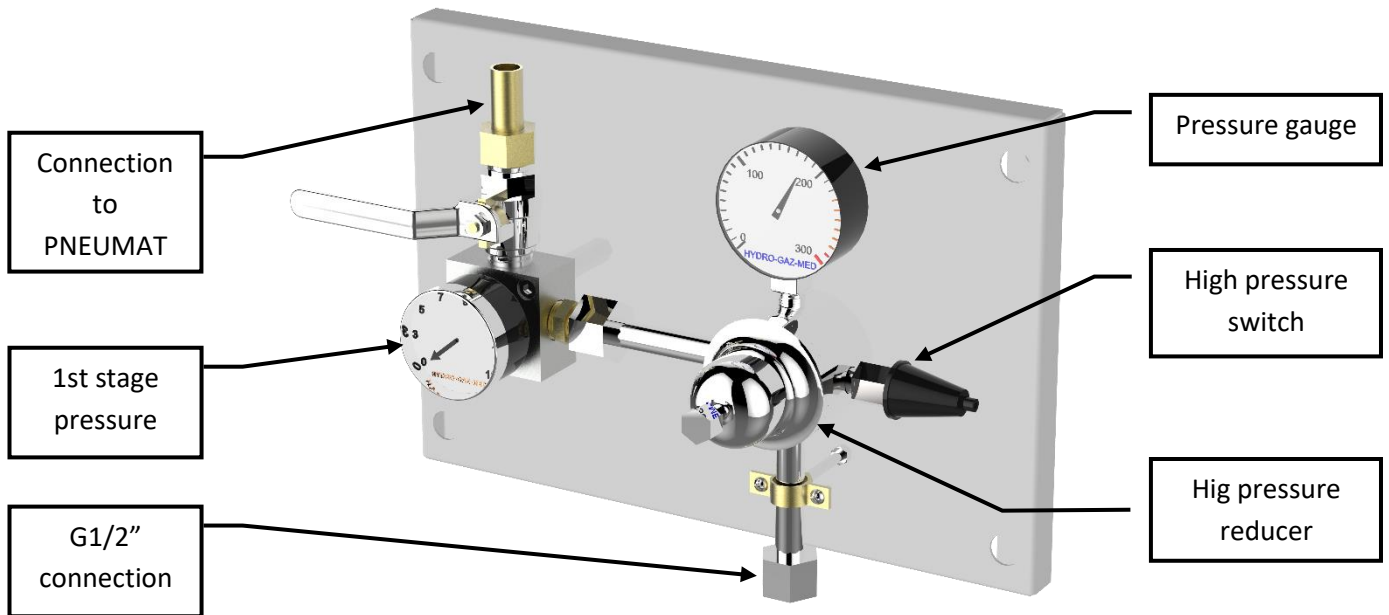

### 13. Double stage reserve panel.

Meant to reduce pressure from reserve cylinders and can be connected directly to hospital network bypassing PNEUMAT. This panel can be used i.e: to reduce pressure from back-up cylinders in compressed air system.

